

ICOS™ T3 & T7 Series

Packaged IC Inspection and Metrology

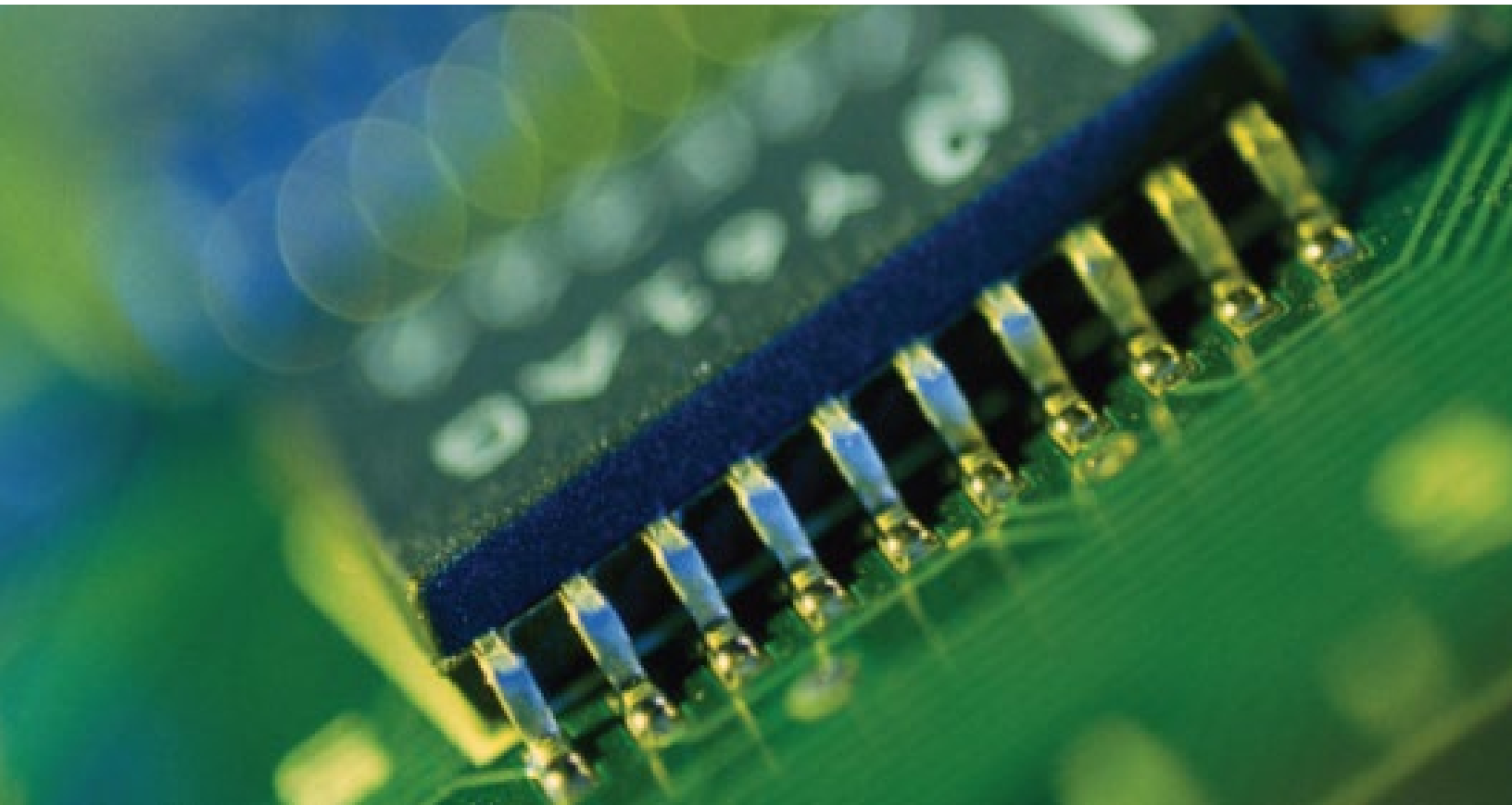

Flexibility & Upgradability

A common platform is used for tools with tray and tape output. Upgrades from tray to tape and vice versa are available for optimal tool use in a changing environment. For customers looking for continuity, the ICOS™ 2CAM, 3CAM and aPVI solutions remain available in the T3 and T7 product family. Upgrades to later technologies are available should the requirements from the end customer change.

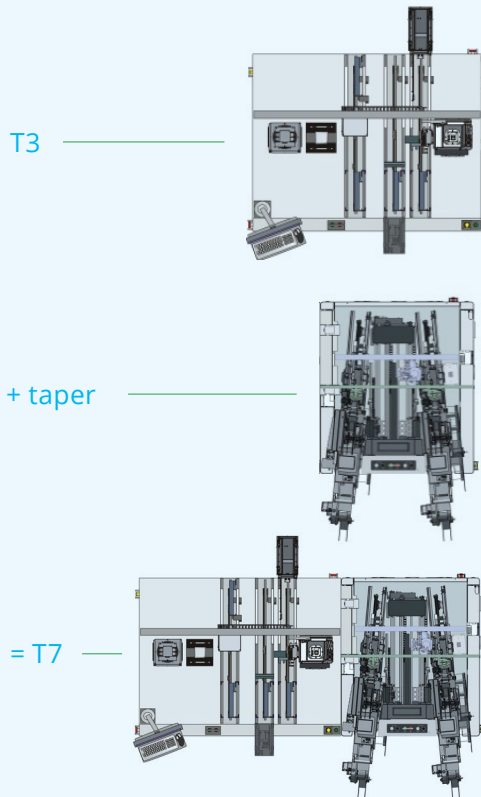

T340

Handler Type

3: Tray output
7: Tape output

Bottom 2D/3D
Module (IS1)

2: 1CAM (2D/5S)
4: 2CAM
8: 3CAM (KITO)
9: SIGMA

ICOS™ T3 & T7 Series



With the T3 & T7 product family, KLA's ICOS division sets a new standard in the inspection of packaged semiconductor ICs. Its highly flexible design provides a solution for every inspection requirement. Base configurations focusing on minimizing cost of ownership, as well as highly advanced models providing solutions for the most challenging quality needs are available. It consolidates decades of experience, research and development into a single platform, making it the most versatile platform on the market today.

Low COO Enabled by Advanced Handling

Motorized Track Conversion (MTC)

This unique feature allows fully automatic changeover of carrier tape and seal positions. On T7, MTC is available as the standard.

Small Device Handling

Due to its unique features, such as dynamic tray compensation, the platform is designed to handle the smallest devices available in trays today.

Faster Dual Taper

The taping module was redesigned to allow faster taping of large devices.

Ultrafast Handling Option

With this option, up to four rows of devices can be inspected in one pickup cycle, achieving unprecedented throughput.

Floor Plan

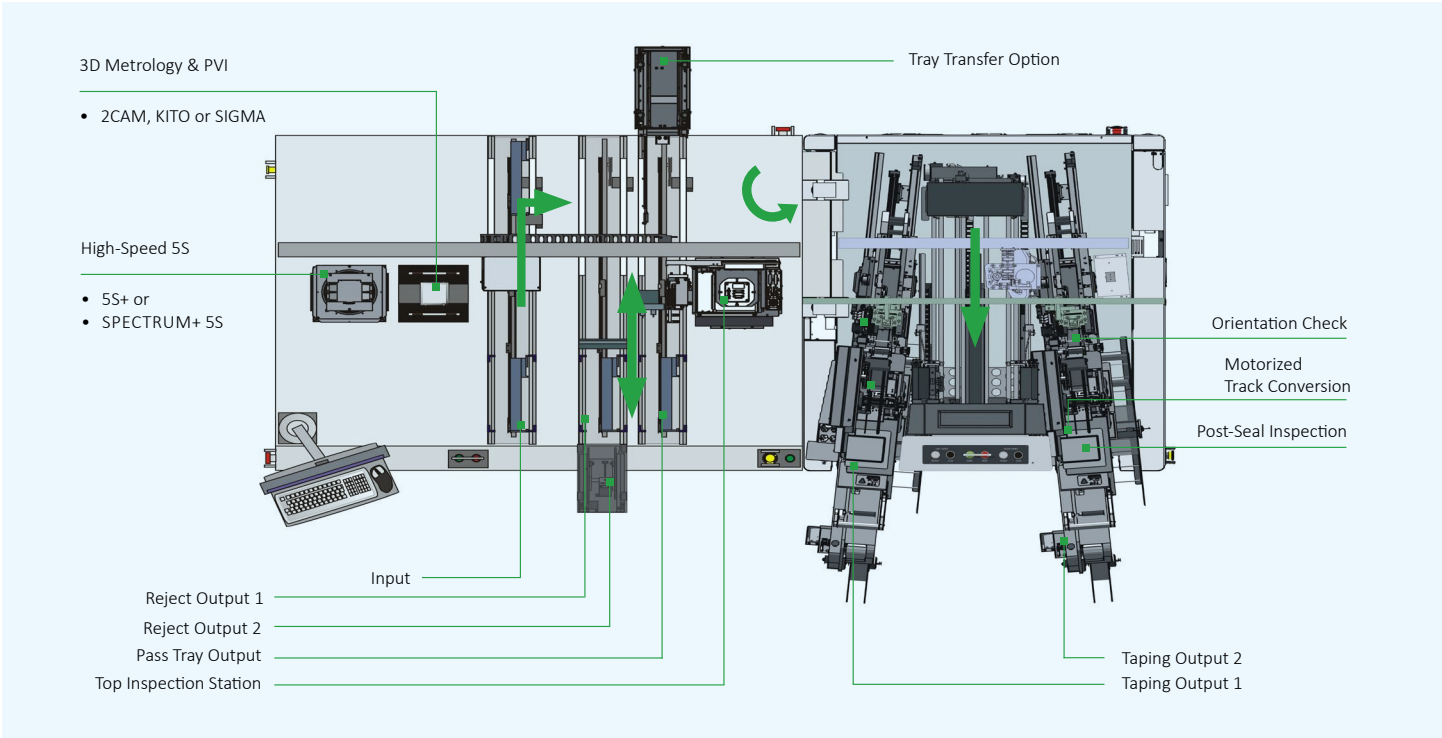

Packaged IC Inspection and Metrology

Increased Sensitivity

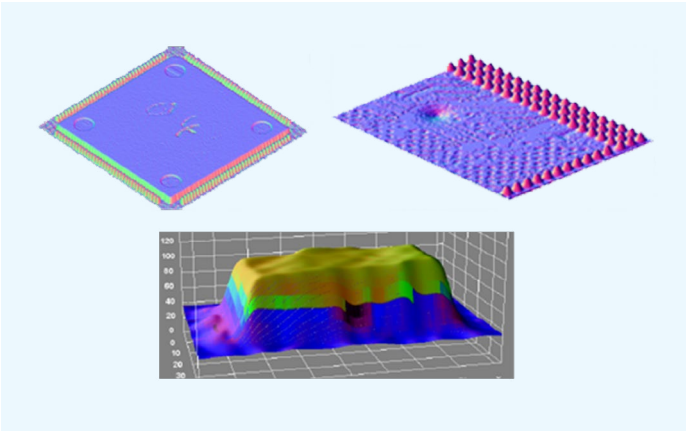

SIGMA: Innovative 3D Metrology

The new-generation ICOS 3D module provides unprecedented inspection capability at unseen accuracy.

- + Best accuracy in back end industry
- + 3D inspection of any object: ball, leads, passive device, solder pad, etc.
- + 3D scan of surfaces to detect and measure dents, bulges
- + Multi-row inspection of TSOP and QFP devices
- + Embedded SPECTRUM+ 2D inspection
- + Accurate component height measurement

SPECTRUM+: Advanced 2D Inspection

SPECTRUM+ is the latest-generation 2D Package Visual Inspection module. It can be applied to inspect both the top and bottom of the device. It can also be embedded inside the Sigma module.

- + Very-high-resolution capability
- + Large FOV with increased homogeneity
- + Color inspection to find defects like discoloration on EMI shields, exposed bond wire, plating defect, etc.
- + Embedded xCrack+™ option to detect fine cracks in silicon or mold
- + Color review imaging

HS5S+ and SPECTRUM+ 5S

High-speed, device side inspection is available in different resolutions and with or without color inspection, depending on the production requirements.

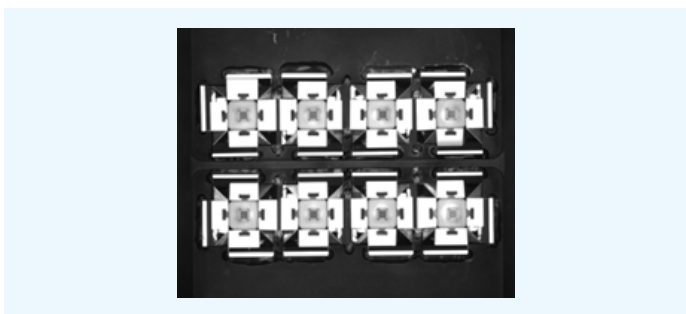
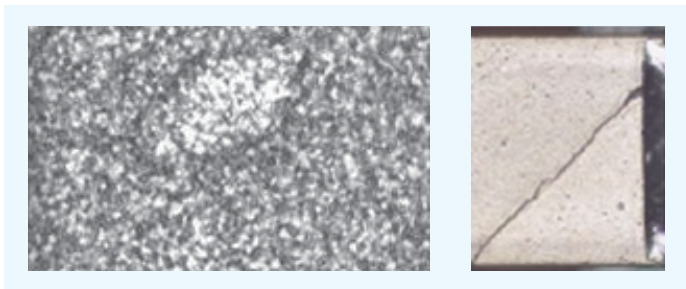

Packaged IC Metrology

2D & 3D Metrology

BGA, CSP, SGA Balls and Solder Pads

The BGA/CSP ball inspection system inspects BGA and CSP devices for critical items such as coplanarity, ball presence, position, offset, pitch, extra ball, body width, ball damage and discolored balls.

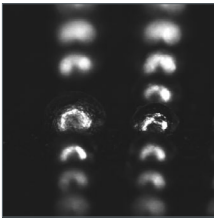

Coplanarity

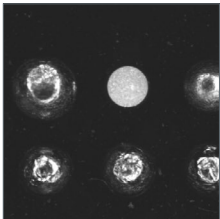

Missing Ball

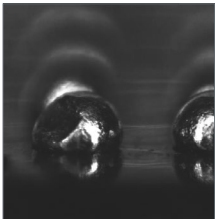

Side Smashed

Generic Shapes

With the latest SIGMA 3D metrology, it is possible to inspect generic features on the device such as passive components and surface dents.

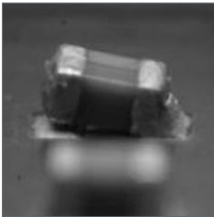

Capacitor Height

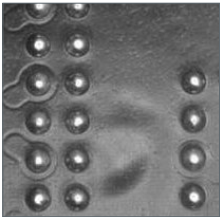

Surface Dent

LGA Lands

The LGA 3D measurement inspects the correctness of the LGA pad grid by measuring 2D and 3D items such as pad coplanarity, offset, pitch and width.

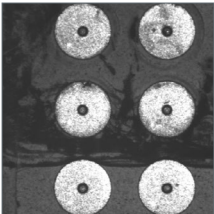

LGA Defect

QFN Pads Lands

This application inspects QFN and other “leadless” packages. The system measures pad position, size, pitch, etc. In addition, it checks body size and edge straightness to control the sawing process.



Bleed on Pad



Chipped Edge

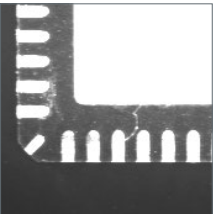

Package Cracks or Scratches

QFP/SOP Leads

The Lead 3D application performs 3D inspection of all gull wing components. It can inspect for items such as lead coplanarity, offset, skew, pitch, length, width, span, sweep, slant, terminal dimension, body standoff and foot angle.

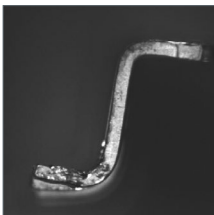

Foot Angle

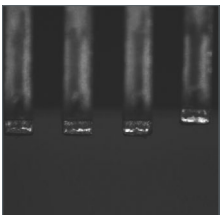

Coplanarity

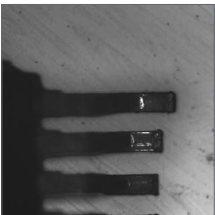

Span

Packaged IC Inspection

Top & Bottom Package Visual Inspection (PVI)

SPECTRUM+ or aPVI

This option offers state-of-the-art inspection of the package surface. It scans the device for voids, scratches, pits, package-incomplete fill, non-homogenous molding, foreign material, chips and similar defects. Due to its highly flexible illumination, a variety of surface materials can be inspected, including plastic mold, exposed silicon, metal surfaces, substrate, etc.

xCrack+™

This option on SPECTRUM+ allows the detection of μ cracks in silicon or mold.

Color Inspection

With this option, defects like discoloration on EMI shields, exposed wire bond copper, plating defects can be detected.

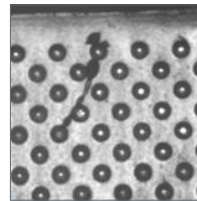

Fiber

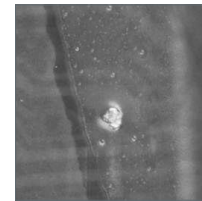

Contamination

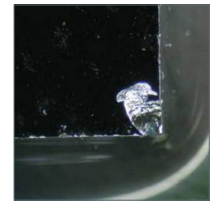

Chip-out

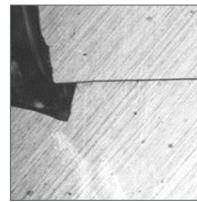

Silicon μ Crack

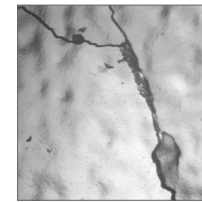

Mold μ Crack

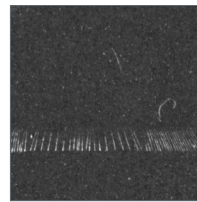

Exposed Wire

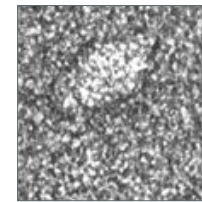

Exposed Copper

5S Inspection

With the High-Speed 5S+ and SPECTRUM+ options, the sides of the devices can be inspected for voids, delamination, cracks, etc.

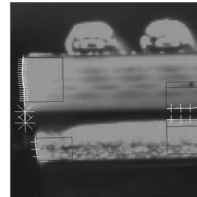

Delamination



Void

Top 2D Land Inspection

This option offers 2D inspection of PoP Lands.

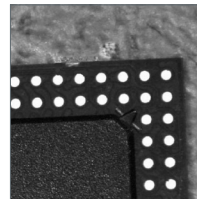

PoP lands

Passive Device Inspection

The PVI software allows for easy setup of complex passive device matrices on flipchip BGA. Passive devices are inspected for presence/absence, chip-out and cracks.

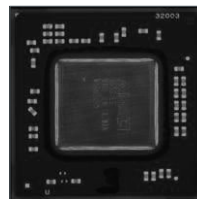

Presence/Absence

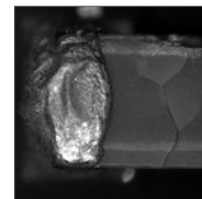

μ Crack



KLA SUPPORT

Maintaining system productivity is an integral part of KLA's yield optimization solution. Efforts in this area include system maintenance, global supply chain management, cost reduction and obsolescence mitigation, system relocation, performance and productivity enhancements, and certified tool resale.

© 2019 KLA Corporation. All brands or product names may be trademarks of their respective companies.

KLA reserves the right to change the hardware and/or software specifications without notice.

KLA Corporation
One Technology Drive
Milpitas, CA 95035
www.kla.com
Printed in the USA
2019-01